

Please write clearly in block capitals.

Centre number

--	--	--	--	--

Candidate number

--	--	--	--

Surname

Forename(s)

Candidate signature

I declare this is my own work.

GCSE MATHEMATICS

H

Higher Tier

Paper 3 Calculator

Monday 7 November 2022

Morning

Time allowed: 1 hour 30 minutes

Materials

For this paper you must have:

- a calculator
- mathematical instruments
- the Formulae Sheet (enclosed).

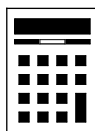

Instructions

- Use black ink or black ball-point pen. Draw diagrams in pencil.
- Fill in the boxes at the top of this page.
- Answer **all** questions.
- You must answer the questions in the spaces provided. Do not write outside the box around each page or on blank pages.
- If you need extra space for your answer(s), use the lined pages at the end of this book. Write the question number against your answer(s).
- Do all rough work in this book. Cross through any work you do not want to be marked.

Information

- The marks for questions are shown in brackets.
- The maximum mark for this paper is 80.
- You may ask for more answer paper, graph paper and tracing paper. These must be tagged securely to this answer book.

Advice

In all calculations, show clearly how you work out your answer.

For Examiner's Use	
Pages	Mark
2–3	
4–5	
6–7	
8–9	
10–11	
12–13	
14–15	
16–17	
18–19	
20–21	
22–23	
24–25	
26–27	
28–29	
TOTAL	



Answer **all** questions in the spaces provided.

Do not write
outside the
box

- 1** $2^x = 32$
Circle the value of x . **[1 mark]**

4

5

6

7

- 2** What is 1.8×10^{-4} as an ordinary number?
Circle your answer. **[1 mark]**

-180 000

-18 000

0.000 18

0.000 018



- 3 Expand $6x^2(x^3 + 2)$
Circle your answer.

[1 mark]

$6x^5 + 2$

$6x^6 + 2$

$6x^5 + 12x^2$

$6x^6 + 12x^2$

- 4 $30 < x < 300$
 x is 200% of y

Circle the correct inequality.

[1 mark]

$10 < y < 100$

$15 < y < 150$

$60 < y < 600$

$90 < y < 900$

Turn over for the next question

Turn over ►

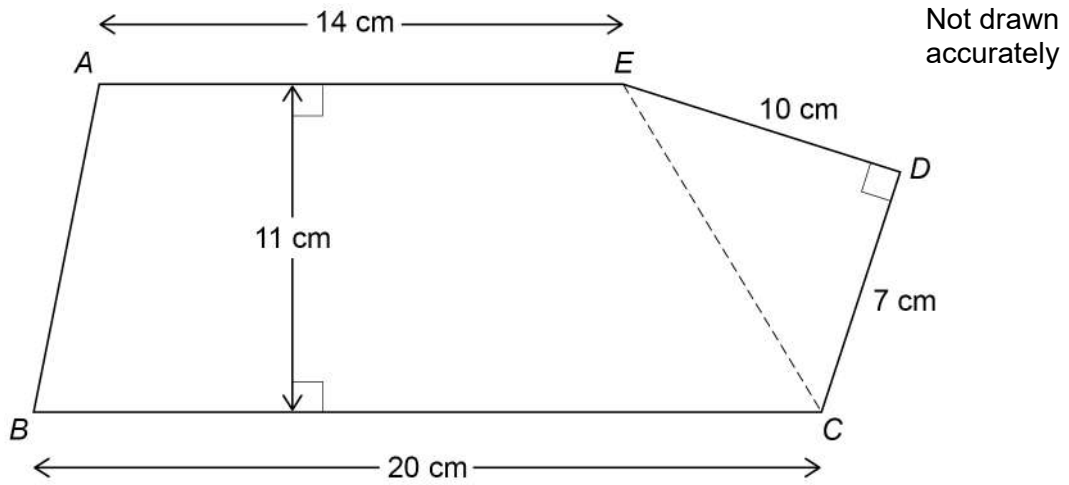

5

 $ABCDE$ is a pentagon.

Work out the area of the pentagon.

[3 marks]

Answer _____ cm^2 

- 7 (a) Here is the rule for a sequence.

After the first two terms, each term is the sum of the previous two terms

The 1st term is 33

The 2nd term is x

The 4th term is 73

Work out the value of x .

[3 marks]

$$x = \underline{\hspace{10cm}}$$

- 7 (b) An expression for the n th term of a different sequence is $n - n^2$

Ruth says,

“All the terms will be negative because n^2 is always greater than n .”

Is she correct?

Tick a box.

Yes

No

Give a reason for your answer.

[1 mark]



8 Here is some information about the members of clubs A and B.

	Number of members	Mean height of members
Club A	24	1.8 m
Club B	20	1.92 m

Work out $\frac{\text{total height of the members of club A}}{\text{total height of the members of club B}}$

Give your answer as a decimal.

[2 marks]

Answer _____

Turn over for the next question



9

P and Q are points.

The x -coordinate of Q is 4 **more** than the x -coordinate of P .

The y -coordinate of Q is 5 **less** than the y -coordinate of P .

Work out the gradient of the straight line through P and Q .

[2 marks]

Answer _____



10 Here are the results after 250 spins of a coin.

Heads	128
Tails	122

The coin is spun an extra 50 times.

After all 300 spins, the relative frequency of Heads is 0.49

For the **extra 50 spins**, work out number of Heads : number of Tails

[3 marks]

Answer _____ : _____

Turn over for the next question



11

Part of a running track is the arc of a semicircle joined to a straight line.

The semicircle has diameter 45 metres.

The straight line has length 75 metres.

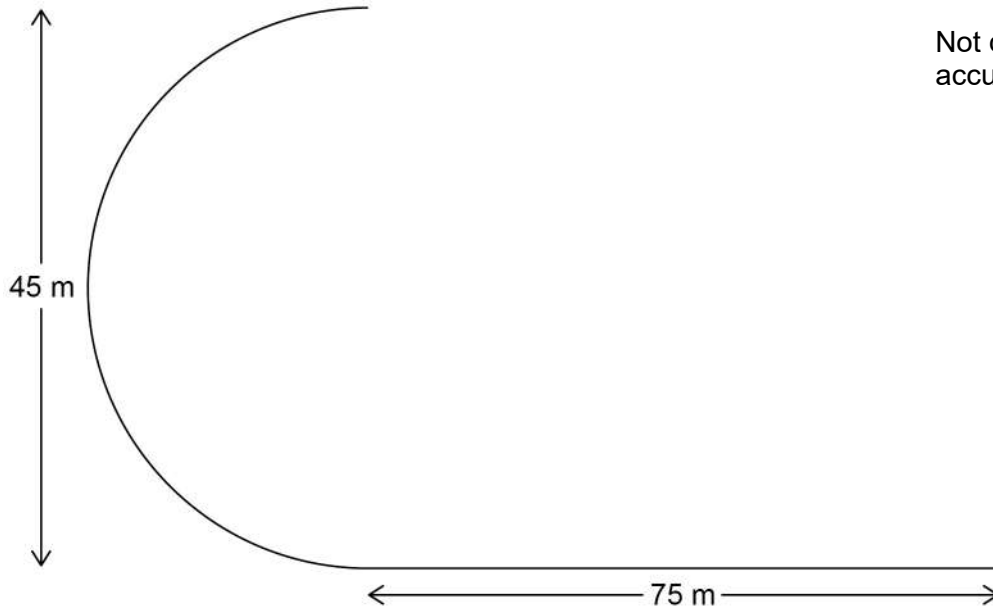

Abby runs once along this part of the track in 18 seconds.

Work out her average speed.

Give your answer to 2 significant figures.

[4 marks]

Answer _____ m/s



12 Triangles ABC and DEF are shown on a grid.

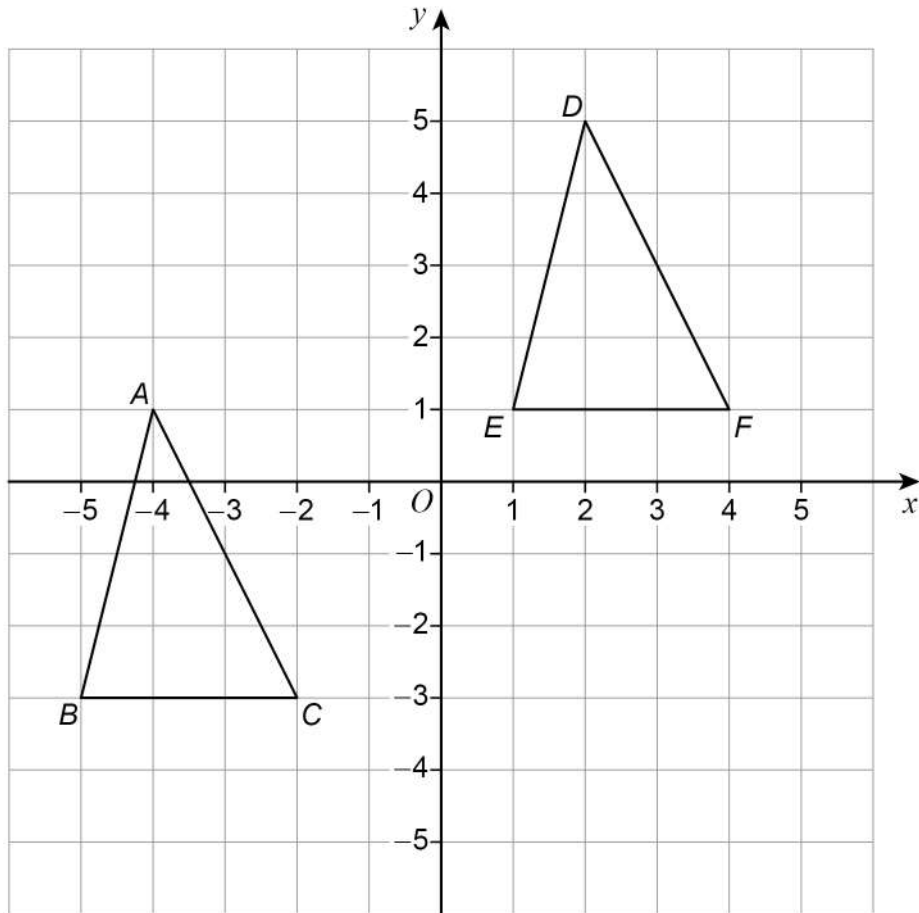

Describe a single transformation that shows the triangles are congruent.

[2 marks]



13 (a) How do the probabilities show that **all** the counters in the bag are red, blue or green?

[1 mark]

13 (b) Circle the probability that the counter is red **or** blue.

[1 mark]

0.0009

0.8

0.03

0.4

13 (c) Circle the probability that the dice lands on an even number **and** the counter is blue.

[1 mark]

0.15

0.3

0.35

0.8

Turn over for the next question



- 14** Here are two solid cubes, X and Y.
The mass of X is 10.976 kg
The area of **each face** of X is 784 cm^2

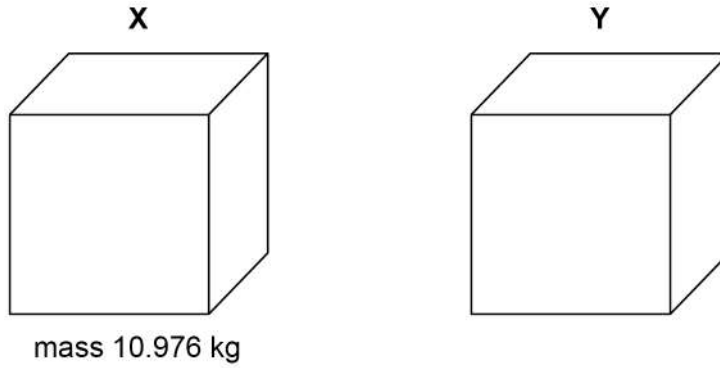

- 14 (a)** Zayan wants to know the density of Y.
He assumes that Y is identical to X.
What density should he get for Y?
Give your answer in **grams per cubic centimetre**.

[4 marks]

Answer _____ g/cm^3



14 (b)

In fact,

the mass of Y is less than the mass of X

the area of each face of Y is greater than the area of each face of X.

What does this mean about the actual density of Y?

Tick **one** box.**[1 mark]**

It is less than the answer to part (a)

It is equal to the answer to part (a)

It is greater than the answer to part (a)

It is not possible to tell

Turn over for the next question**Turn over ►**

15

A mobile phone takes 2 hours to charge from empty.

When the phone is being charged, the current flow into the phone

- starts at full current flow (100%)
- continues at full current flow for a period of time
- gradually decreases until the phone is fully charged.

This is shown on **Graph A** below.

Graph A

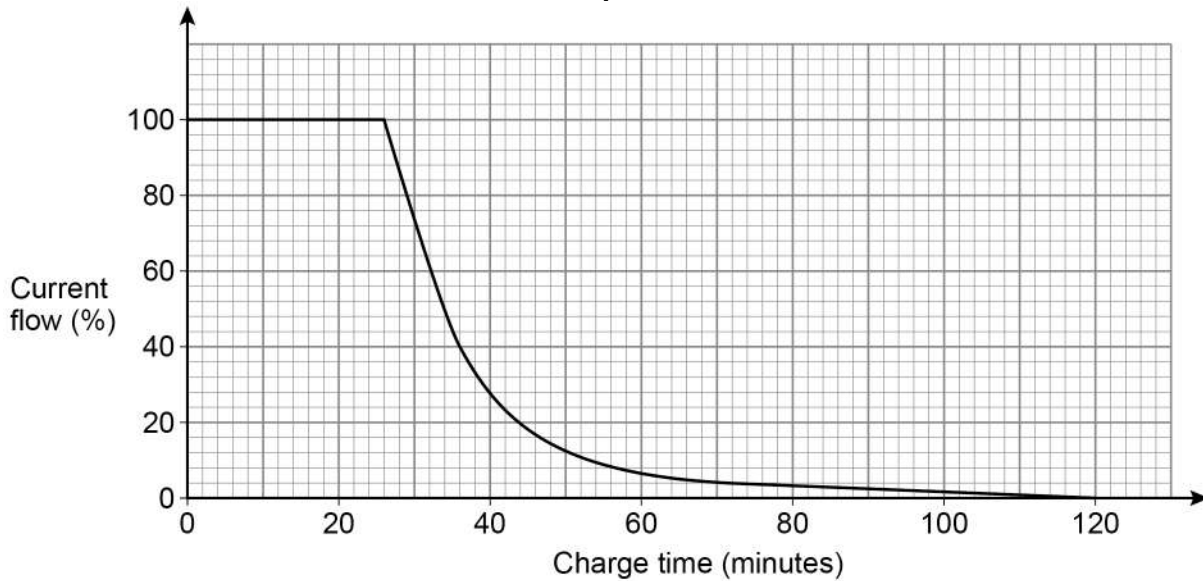

Graph B shows the percentage charge in the phone when charging from empty.

Graph B

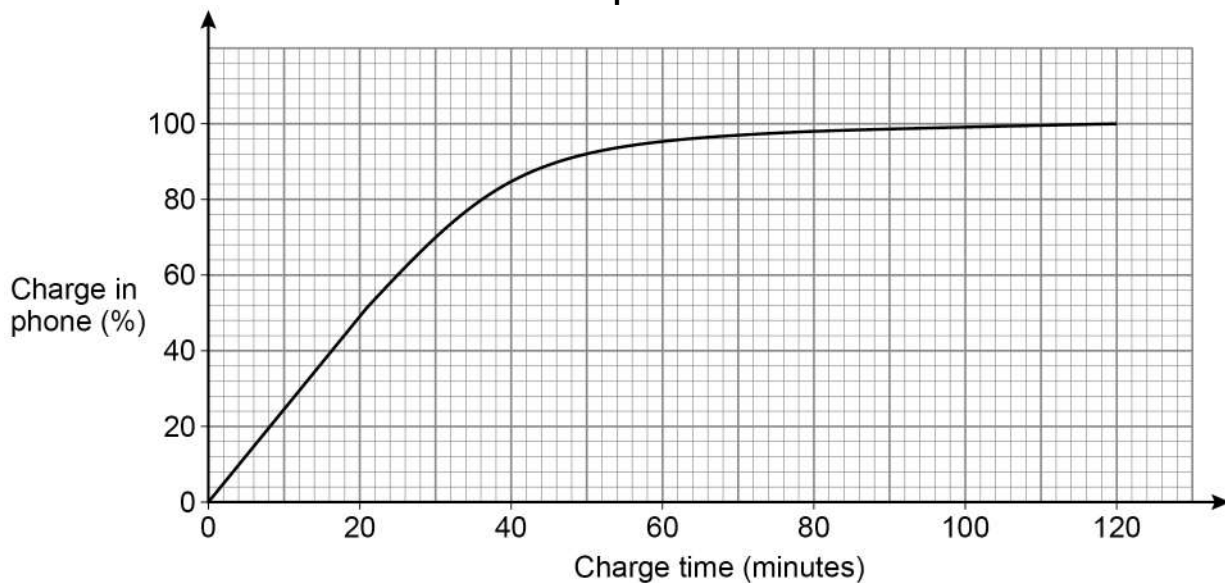

Megan's phone is empty of charge.
She starts to charge her phone at 10.00 am

- 15 (a)** Using **Graph A**,
estimate the time when the current flow starts to decrease.

[2 marks]

Answer _____ am

- 15 (b)** Using **Graph A and Graph B**,
estimate the percentage charge in the phone when the current flow is 40%

[1 mark]

Answer _____ %

- 15 (c)** Using **Graph B**,
estimate the rate of increase in the percentage charge when the phone has 90% charge.

[2 marks]

Answer _____ percent per minute



16 H is inversely proportional to the cube root of L .

$$H = 7 \quad \text{when} \quad L = 64$$

16 (a) Work out an equation connecting H and L .

[3 marks]

Answer _____

16 (b) Work out the value of H when $L = 2744$

[2 marks]

$H =$ _____



- 17 A , B and C are points on a circle, centre O .
 BD is a tangent to the circle.
 OCD is a straight line.

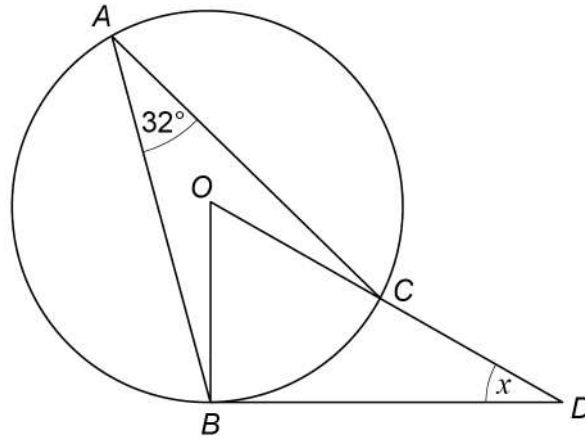

Not drawn
accurately

Work out the size of angle x .

[3 marks]

$x =$ _____ degrees



18 Rearrange $9m + 4(2m - 1) = p^2 + pm$ to make m the subject.

[4 marks]

Answer _____

19 A circle has centre $(0, 0)$ and passes through $(0, 11)$

Write down the equation of the circle.

[1 mark]

Answer _____



20 There should be a train leaving a station every hour from 7 am
No trains leave early.

$P(\text{the first train leaves on time}) = 0.9$

For all the **other trains**,

if the previous train did leave on time, $P(\text{this train leaves on time}) = 0.8$

if the previous train did **not** leave on time, $P(\text{this train leaves on time}) = 0.65$

20 (a) Work out $P(\text{the first three trains leave on time})$

[2 marks]

Answer _____

20 (b) The 2 pm train does **not** leave on time.

Work out $P(\text{exactly one of the next two trains does not leave on time})$

[3 marks]

Answer _____



21 Shape A is enlarged to shape B.

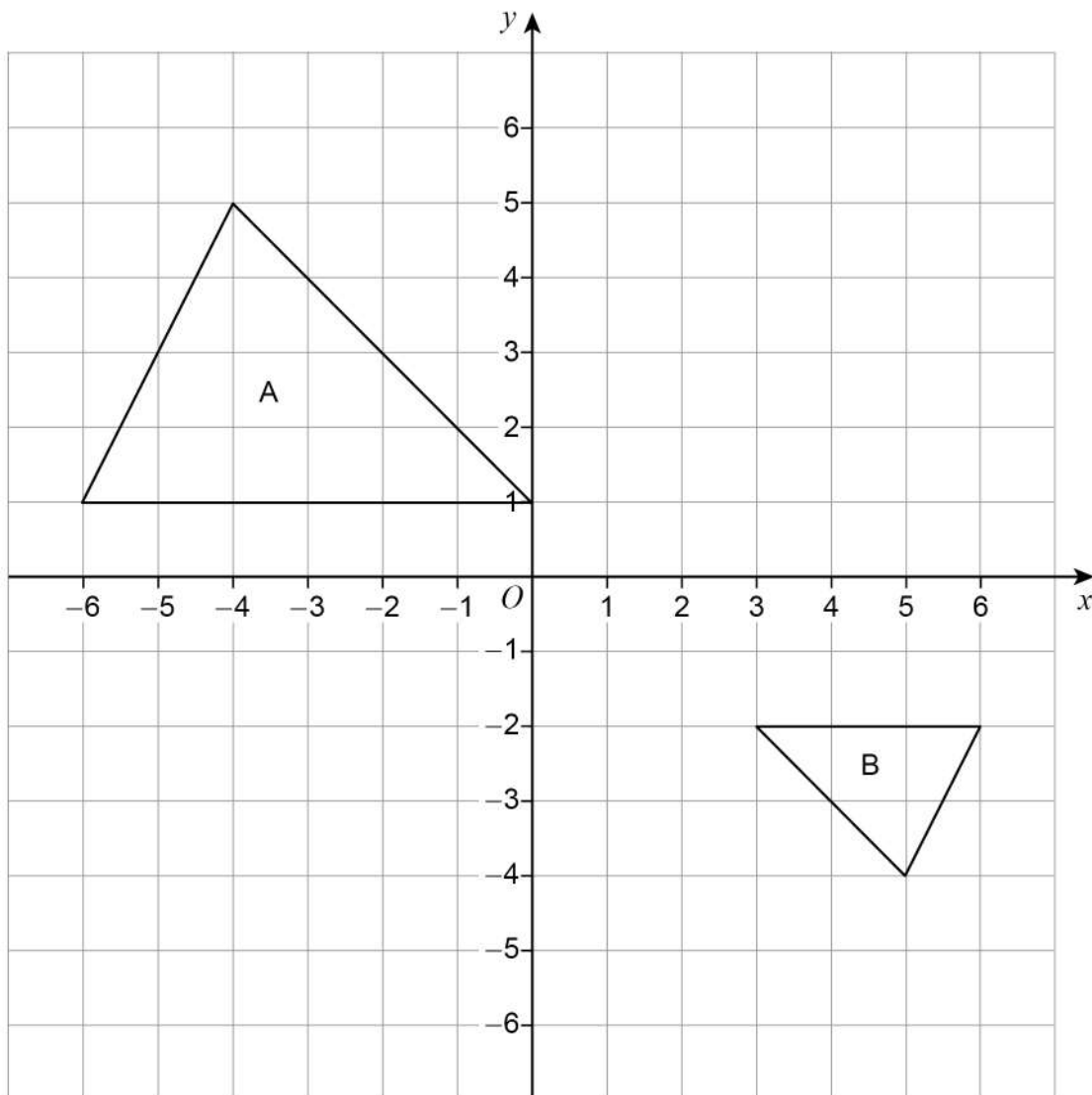

21 (a) Circle the scale factor of the enlargement.

[1 mark]

$$-\frac{1}{2}$$

$$-2$$

$$\frac{1}{2}$$

$$2$$

21 (b) Write down the coordinates of the centre of enlargement.

[1 mark]

Answer (_____ , _____)



22

Simplify fully $\frac{2}{x+1} + \frac{7-5x}{3} + 4x$

Give your answer as a single fraction.

[4 marks]

Answer _____

<hr/>
6

Turn over ►

23

Alec makes a bowl for dog food from a solid wooden cone.

The sketches show how the bowl is made.

The cone has radius 9 cm and perpendicular height 30 cm

A smaller cone, with radius 6 cm, is removed.

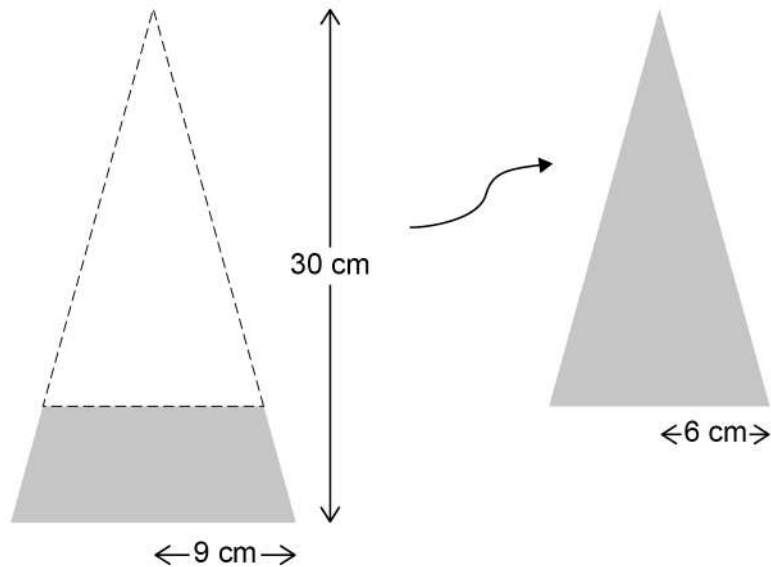

Not drawn
accurately

$$\text{Volume of a cone} = \frac{1}{3} \pi r^2 h$$

where r is the radius and h is the perpendicular height

A hemisphere with radius 6 cm is then removed.

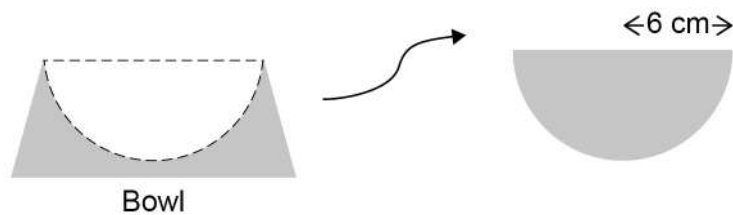

Not drawn
accurately

$$\text{Volume of a hemisphere} = \frac{2}{3} \pi r^3 \quad \text{where } r \text{ is the radius}$$



25

Two sides of a triangle are measured to 1 decimal place.
The angle between the sides is measured to the nearest degree.

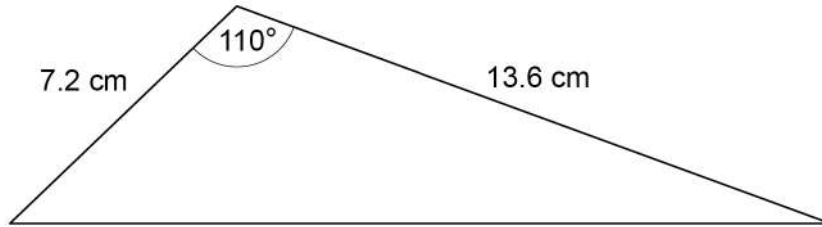
Not drawn
accurately

Work out the upper bound for the area of the triangle.

You **must** show your working.

[4 marks]

Answer _____ cm^2

Turn over for the next question



26 Here is a sketch of the graph of $y = 5^x$

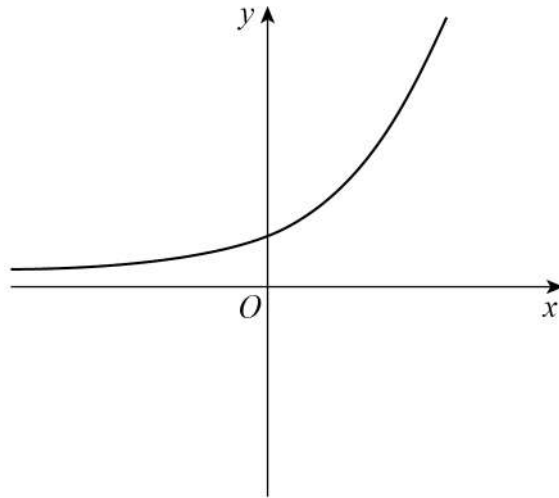

In parts (a) and (b) the sketch of $y = 5^x$ is shown as a dashed line.

26 (a) On the axes below, sketch the graph of $y = -5^x$

[1 mark]

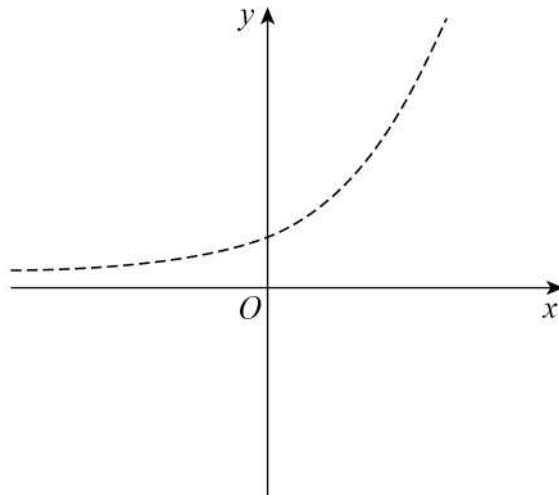

26 (b) On the axes below, sketch the graph of $y = 5^x - 1$

[1 mark]

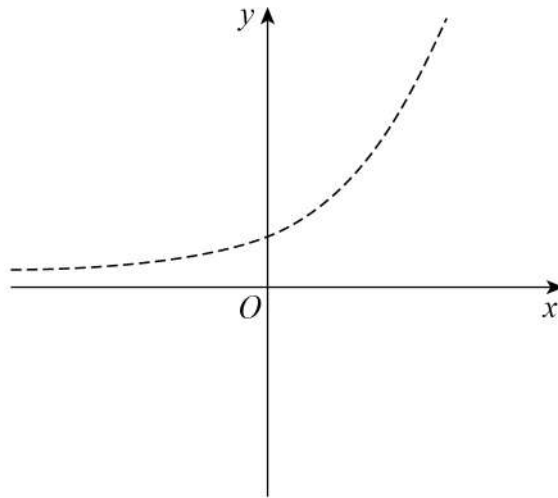

END OF QUESTIONS



There are no questions printed on this page

*Do not write
outside the
box*

**DO NOT WRITE ON THIS PAGE
ANSWER IN THE SPACES PROVIDED**



